

# Distributing Circuits Over Heterogeneous, Modular Quantum Computing Networks

---

Pablo Andres-Martinez, Tim Forrer, **Dan Mills**,  
Jun-Yi Wu, Luciana Henaut, Kentaro Yamamoto,  
Mio Muraio, Ross Duncan



$$e\text{-bit} = \frac{1}{\sqrt{2}}(|00\rangle + |11\rangle)$$

Initial shared entanglement

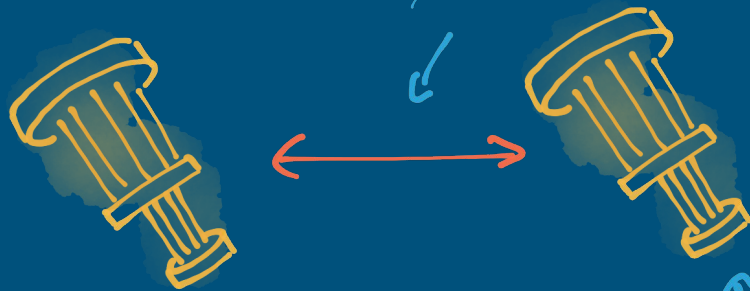

Local Operations  
& Classical Communication

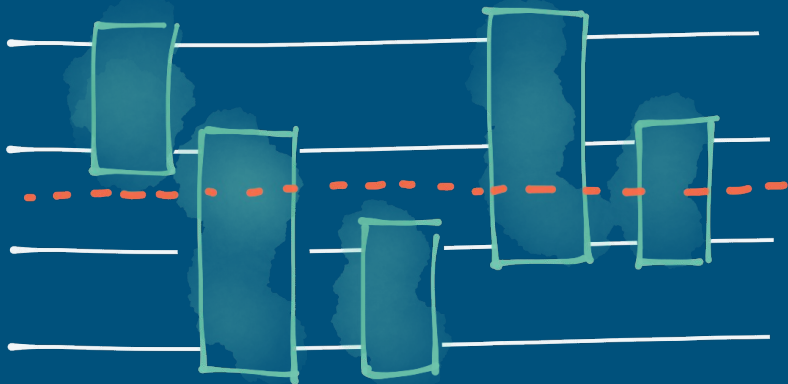

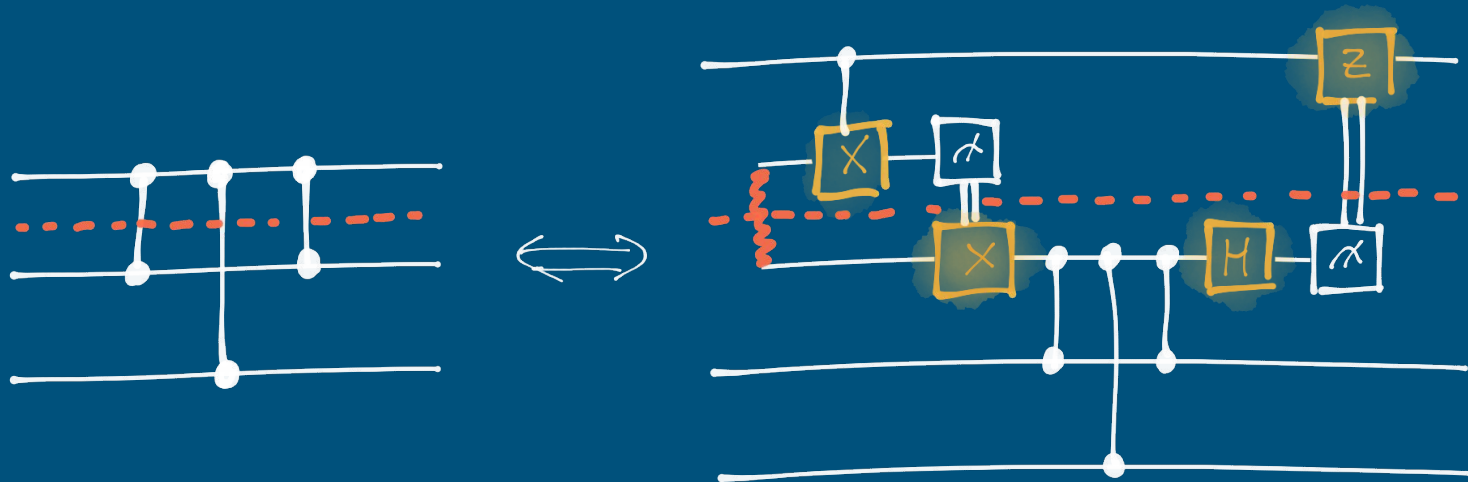

Optimal local implementation of non-local quantum gates

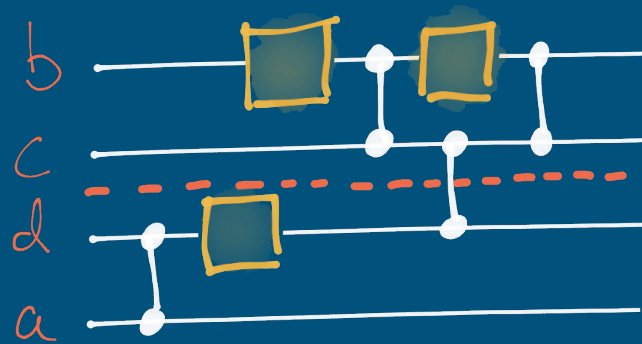
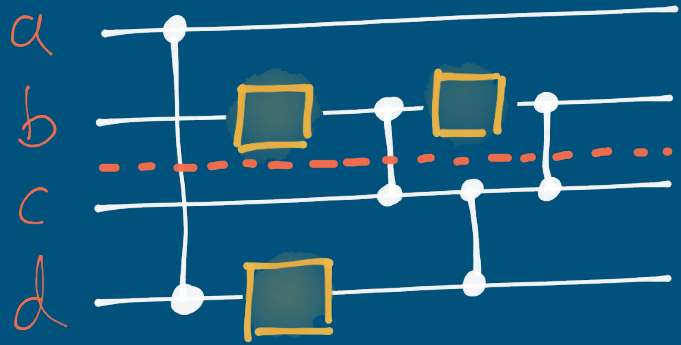

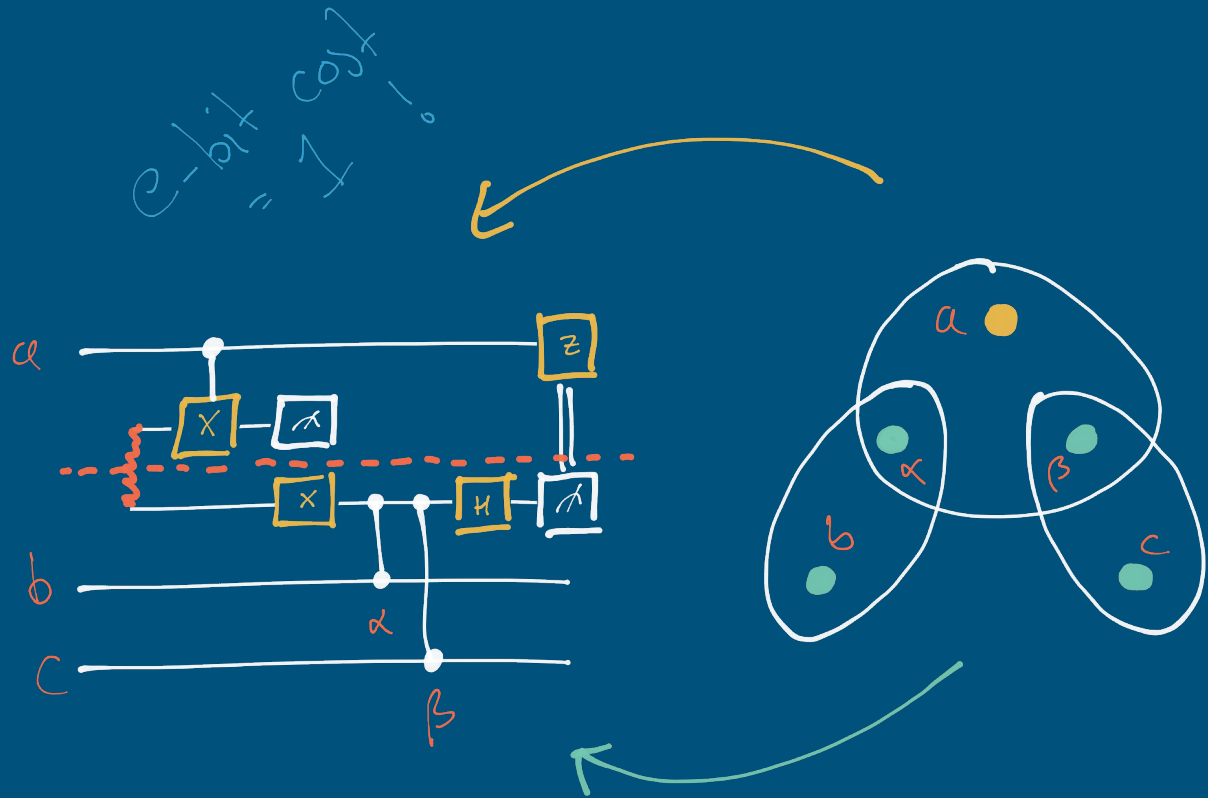

Automated distribution of quantum circuits via hypergraph partitioning

# Heterogeneous Networks

---

- Modules of different sizes.
- Entanglement distribution.
- Qubit allocation and non-local gate distribution.
- Embedding.

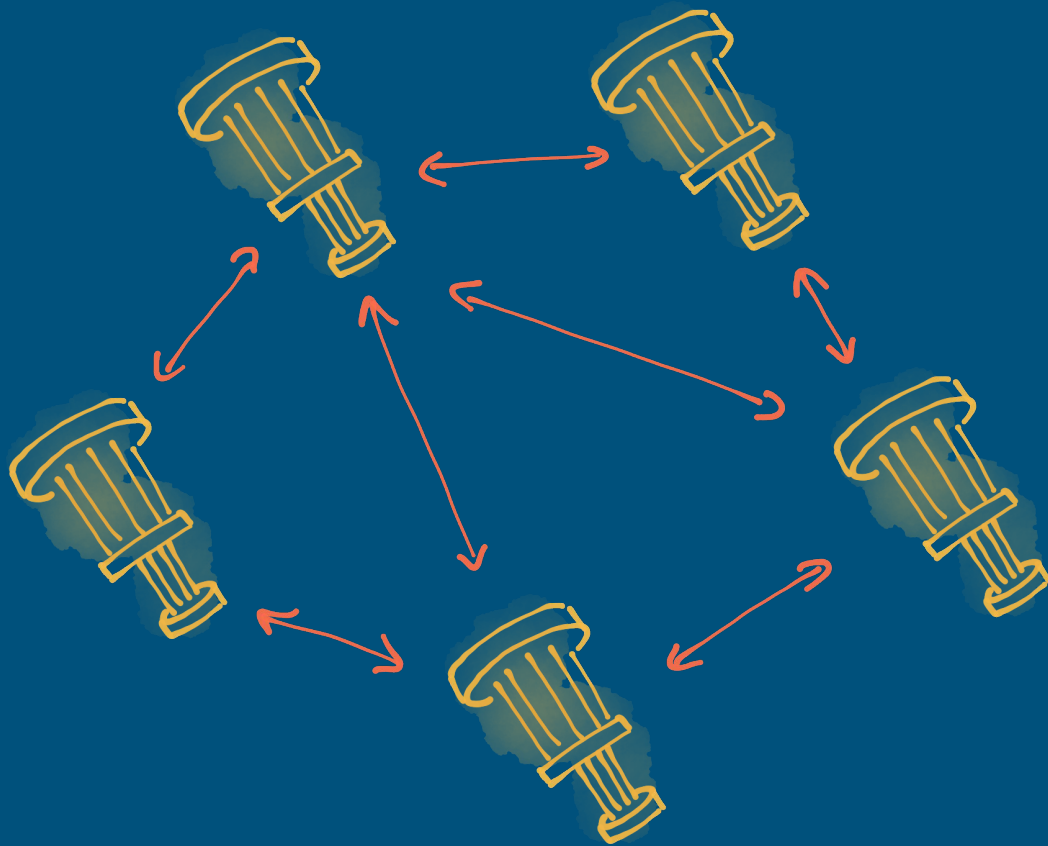

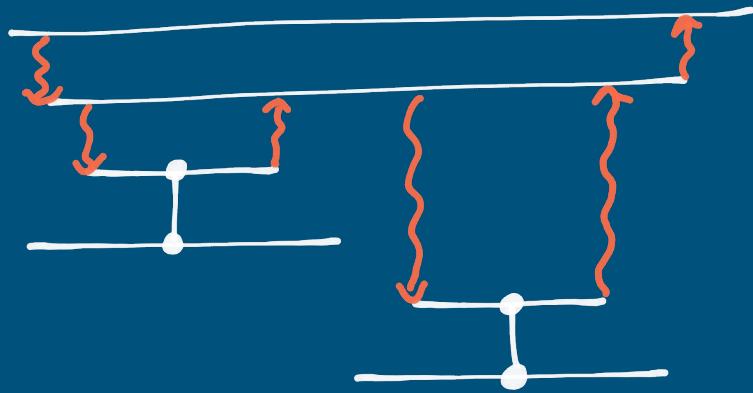
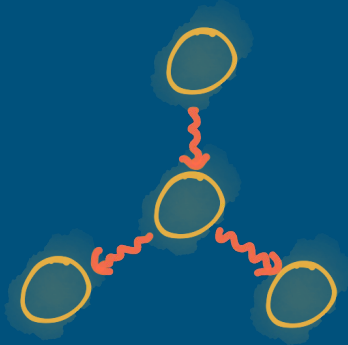
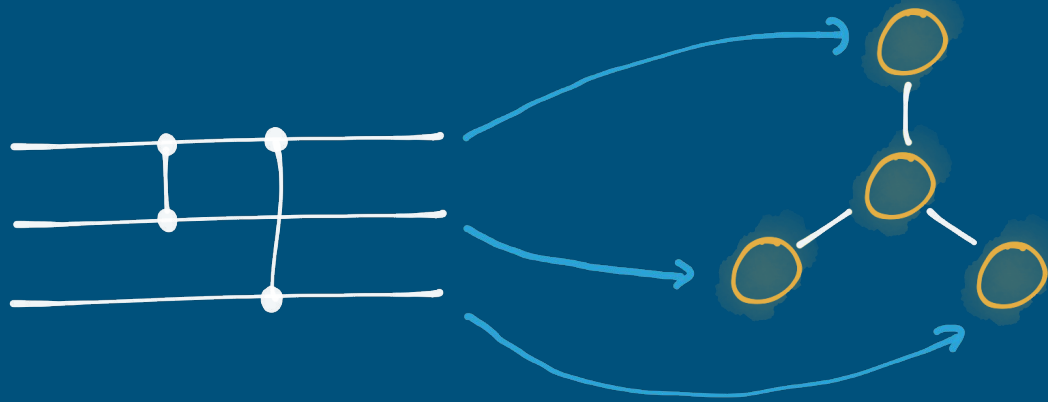



# Qubit Allocation and Non-Local Gate Distribution

---

Rounds of updates:

- Move vertices to new module:
  - Gates move freely.
  - Qubits memory bound.
- Calculate cost.
- Rollback or commit.

Two techniques:

- General purpose annealing.
- Modified graph partitioning.



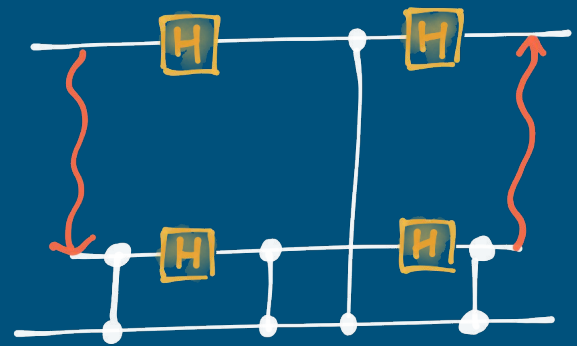
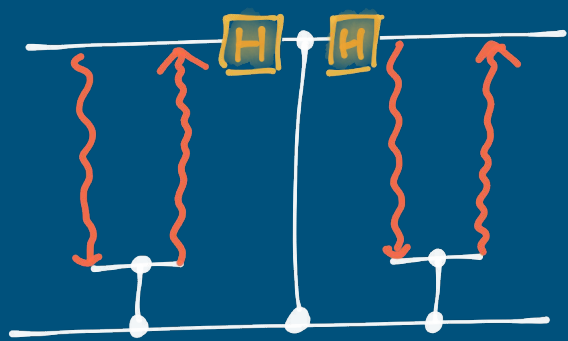
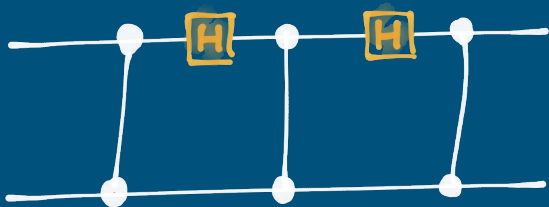

Entanglement-efficient bipartite-distributed quantum computing with entanglement-assisted packing processes

(a)

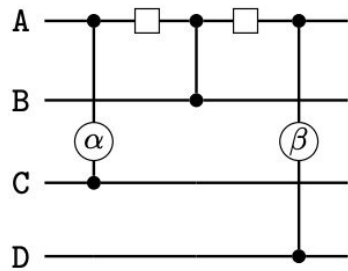

(b)

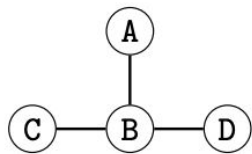

(c)

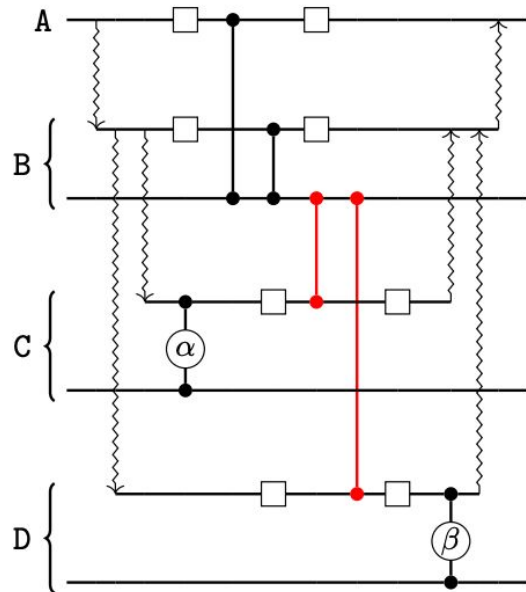

(d)

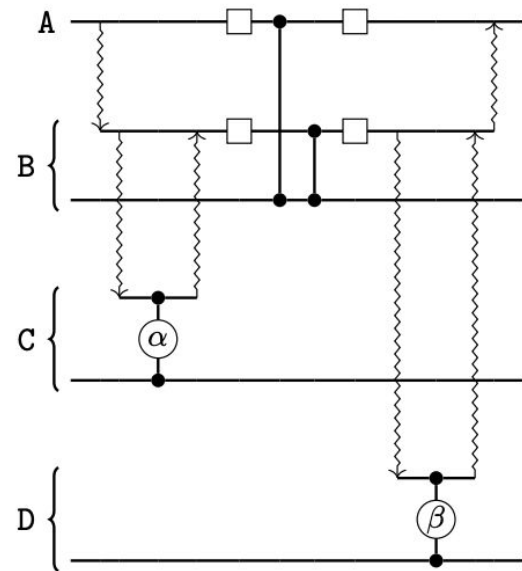

# Benchmarks and Implementation

Automated Distribution of Quantum Circuits with pytket-dqc

- Rebase to CRz
  - Qubit allocation
  - Gate packing
  - Non-local gate distribution
  - Refinement
  - Circuit generation
-

# Key Findings

- Each refinement improves the median cost of Pauli Gadget circuits.
- Refinement has little effect on Quantum Volume circuits.
- Techniques combined perform best

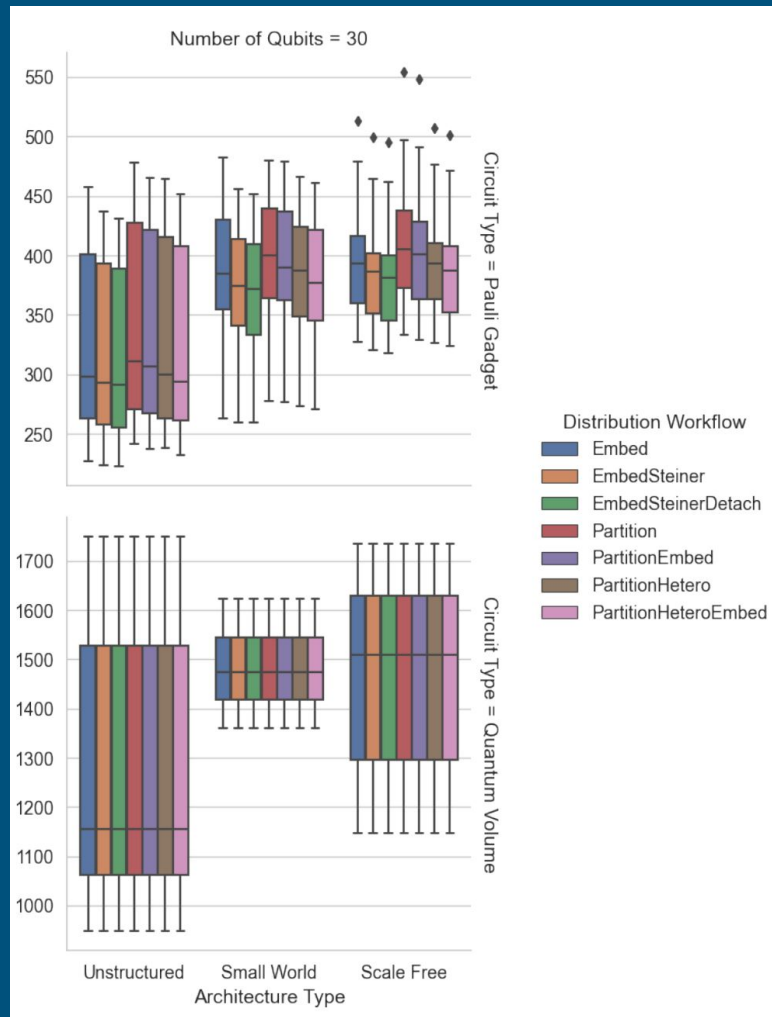

# Remarks

- Application benchmarks
- Homogeneous networks
- Bound link qubit registers
- Circuit generation
- pytket-dqc

```
1 from pytket_dqc.distributors import CoverEmbedding
2 from pytket_dqc import NISQNetwork, DQCPass
3 from pytket import Circuit
4 from pytket.circuit.display import render_circuit_jupyter
5
6 network = NISQNetwork([[0,1]], {0:[0], 1:[1]})
7
8 circ = Circuit(2).CZ(0,1)
9 render_circuit_jupyter(circ)
10
11 DQCPass().apply(circ)
12 distribution = CoverEmbedding().distribute(circ, network, seed=0)
13 circ_with_dist = distribution.to_pytket_circuit()
14 render_circuit_jupyter(circ_with_dist)
```

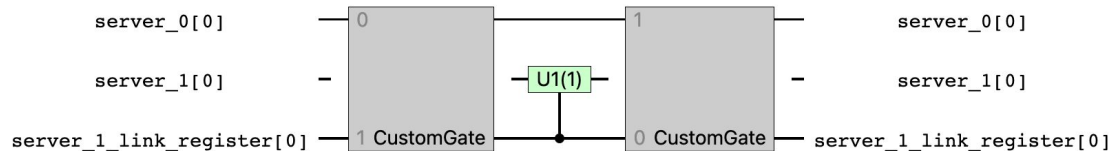
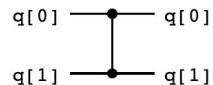

# Cheers

[arxiv.org/abs/2305.14148](https://arxiv.org/abs/2305.14148)

**Distributing circuits over  
heterogeneous, modular quantum  
computing network architectures**

—

Entanglement-efficient bipartite-distributed  
quantum computing with  
entanglement-assisted packing processes

[arxiv.org/abs/2212.12688](https://arxiv.org/abs/2212.12688)

---